

Codice articolo Product code:	2001029
Descrizione Description:	PRESA CCS CAT.6A RJ45 SCHERMATA STP EASY CRIMP COMPACT - T568A/B CAT.6A CCS EASY CRIMP COMPACT SHIELDED STP RJ45 JACK - T568A/B



Descrizione

Presca CCS RJ45 Easy Crimp Compact di categoria 6A schermata per soluzioni installative ad alta densità per la realizzazione di canali trasmissivi in Categoria 6A / Classe EA.
Supporta applicazioni 10Gigabit Ethernet (IEEE 802.3an).
Idonee per PoE/PoE+/PoE++ (IEEE 802.3af/at/bt).

Prestazioni

Certificazioni	GHMT and Force Technology Cat. 6A Component Level
Standards	ISO/IEC 11801-1:2017 (Ed. 1.0) ISO/IEC 11801-2:2017 (Ed. 1.0) IEC 60603-7-51:2010 (Ed. 2.0) EN 50173-1: 2018 EN 50173-2:2018 ANSI/TIA-568.2-D. IEC 60512-99-002

Caratteristiche costruttive

Tipo di presa	Presca RJ45 compatibile con lo standard Keystone - T568A/B Easy Crimp Compact
Contatti	In lega di bronzo placcati oro 50 µm
Materiale di isolamento	Termoplastico ad alta resistenza meccanica, ritardante la fiamma tipo UL94V-0
Schermatura	Lega di zinco die-cast
Assemblaggio	Terminazione universale a perforazione d'isolamento EASY CRIMP per connessioni facili e veloci che non necessitano l'utilizzo di utensili; per conduttori solidi o a trefolo da 22/26 AWG
Etichettatura	Doppia etichetta con schema di connessione T568A/B
Identificazioni e loghi	Logo CCS, P/N

Caratteristiche meccaniche

Forza totale di tenuta	Min. 800 gr con tutti gli 8 conduttori
Tenuta	Max. 50N tra spina e presa
N° cicli di inserzione spine	Min. 750 cicli

Condizioni di utilizzo e stoccaggio

Temperatura di stoccaggio	Da -40°C a +70°C
Temperatura di lavoro	Da -10°C a +60°C
Umidità relativa	Max. 85% senza condensazione

Description

CAT. 6A CCS Easy Crimp Compact shielded RJ45 jack for high density installation solutions, ideal for the realization of transmission channels of Category 6A / Class EA.
It supports 10Gigabit Ethernet applications (IEEE 802.3an) and is suitable for PoE/PoE+/PoE++ (IEEE 802.3af/at/bt).

Performance

Certifications	GHMT and Force Technology Cat. 6A Component Level
Approvals	ISO/IEC 11801-1:2017 (Ed. 1.0) ISO/IEC 11801-2:2017 (Ed. 1.0) IEC 60603-7-51:2010 (Ed. 2.0) EN 50173-1: 2018 EN 50173-2:2018 ANSI/TIA-568.2-D. IEC 60512-99-002

Construction characteristics

Jack type	RJ45 jack compatible with Keystone standard- T568A/B Easy Crimp Compact
Contacts	Phosphor bronze alloy plated with 50µm of gold
Insulation material	Polycarbonate, high-impact, flame retardant plastic, UL94V-0 rated
Shield	Zinc alloy die-casting
Assembly	Easy Crimp termination system for fast and easy connection without the use of tools; for solid or stranded copper conductors of diameter from 22 to 26 AWG
Label	Double label indicating T568A/B connection scheme
Printing	CCS Logo, P/N

Mechanical properties

Total mating force	Min. 800 gr for an 8 wire leads
Retention	Max. 50N between the jack and plug
Insertion-extraction life	Min. 750 cycles

Environmental conditions

Storage temperature	From -40°C to +70°C
Operating temperature	From -10°C to +60°C
Relative humidity	Maximum non-condensing 85%

Codice articolo Product code:	2001029
Descrizione Description:	PRESA CCS CAT.6A RJ45 SCHERMATA STP EASY CRIMP COMPACT - T568A/B CAT.6A CCS EASY CRIMP COMPACT SHIELDED STP RJ45 JACK - T568A/B

Caratteristiche elettriche

Impedenza caratteristica	100±15 Ohm
Resistenza di contatto	Max. 20 mOhm
Corrente limite	1,5A a 20°C
Max. tensione di lavoro	< 50Vac / < 75Vdc
Resistenza di isolamento	Min. 500 MOhm @ 100 Vdc
Tensione di tenuta	1,0 kVac per 1 minuto

Electrical properties

Characteristic impedance	100±15 Ohm
Contact resistance	Max. 20 mOhm
Current rating	1,5A at 20°C
Max. voltage rating	< 50Vac / < 75Vdc
Insulation resistance	Min. 500 MOhm @ 100 Vdc
Dielectric withstanding voltage	1,0 kVac for 1 minute

Confezionamento

Confezione	120x60x50 mm
Peso	200 gr
Ogni confezione include	- 8 prese CCS RJ45 CAT. 6A Easy Crimp Compact schermata - Istruzioni assemblaggio

Packaging

Packing	120x60x50 mm
Weight	200 gr
Each package includes	- 8 CAT. 6A CCS Easy Crimp Compact shielded RJ45 jacks - Mounting instructions

Garanzia

30 anni sul sistema CCS

Warranty

30 years on the CCS system

PROPRIETA' TRASMISSIVE / TRANSMISSION PROPERTIES

Freq MHz	Attenuation dB/100m Maximum	NEXT dB Minimum	FEXT dB Minimum	RL dB Minimum
1	0,1	75	75	30
4	0,1	75	71,1	30
8	0,1	75	65	30
16	0,1	69,9	59	30
31.25	0,11	64,1	53,2	30
62.5	0,16	58,1	47,2	30
100	0,20	54	43,1	28
200	0,28	48	37,1	22
250	0,32	46	35,1	20
300	0.35	42.9	33.6	18.5
400	0.40	37.9	31.1	16
500	0.45	34.0	29.1	14

SCHEMA ASSEMBLAGGIO / ASSEMBLY SCHEME

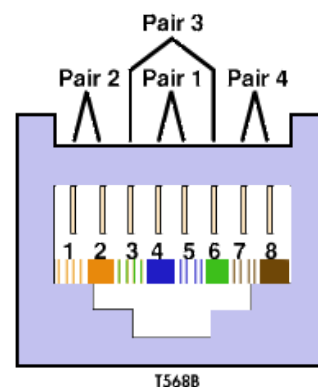
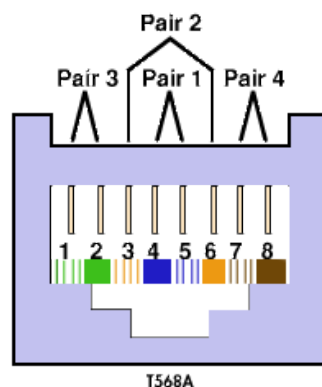

Codice articolo Product code:	2001029
Descrizione Description:	PRESA CCS CAT.6A RJ45 SCHERMATA STP EASY CRIMP COMPACT - T568A/B CAT.6A CCS EASY CRIMP COMPACT SHIELDED STP RJ45 JACK - T568A/B

DISEGNI TECNICI / TECHNICAL DRAWINGS

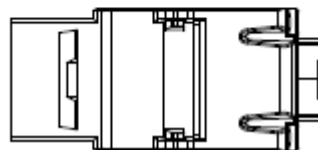
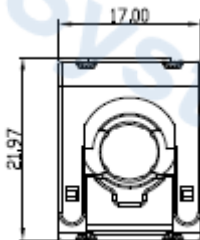
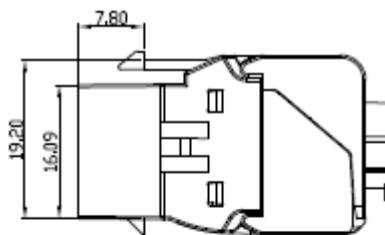
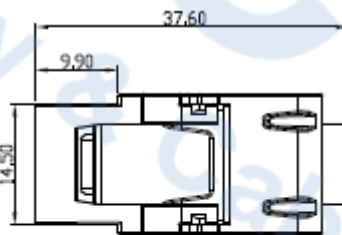
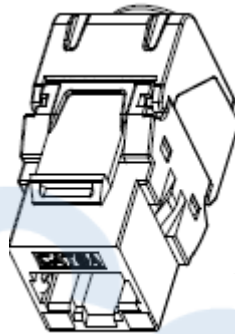

Codice articolo Product code:	2001029
Descrizione Description:	PRESA CCS CAT.6A RJ45 SCHERMATA STP EASY CRIMP COMPACT - T568A/B CAT.6A CCS EASY CRIMP COMPACT SHIELDED STP RJ45 JACK - T568A/B

PROCEDURA DI ASSEMBLAGGIO DELLA PRESA / JACK ASSEMBLY INSTRUCTION

- 1) Tagliare la guaina esterna del cavo per circa 40 mm.
 - 1a) Cavo S/FTP PiMF: ripiegare all'indietro la treccia in rame; tagliare il foglio in alluminio di ciascuna coppia di conduttori lasciando 6 mm
 - 1b) Cavo F/UTP e F/FTP: tagliare i fogli d'alluminio sul cordato e/o sulle singole coppie e ripiegare all'indietro il filo di continuità

Strip off 40 mm of cable jacket

- 1a) Cable S/FTP PiMF: fold the braid back over the cable; cut off aluminum foil up to 6mm for each pair, use copper foil to shield the cable
- 1a) Cable F/UTP and F/FTP: cut the overall and/or each pair aluminum foil and fold back the drain wire over the cable

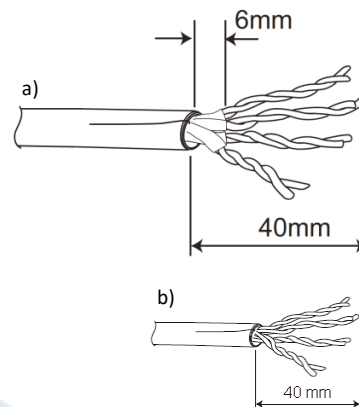

- 1) Inserire il cavo nel coperchio di terminazione e disporre i conduttori nelle apposite cavità di inserzione seguendo la codifica colori T568A o T568B; tagliare le eccedenze di ciascun conduttore

Insert the cable into the termination cap and fan out all four twisted pairs. Put the conductors in the proper connection slots according to T568A or T568B termination color and trim the ends of the conductors

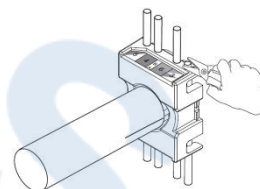

- 3) Agganziare il coperchio di terminazione alla presa in modo tale che le frecce di inserzione presenti sulle due parti combacino; gli appositi ganci laterali manterranno il coperchio nella posizione corretta per il crimpaggio

Install the termination cap to the jack by following the insertion arrow. The side locks will keep it in the right position for the crimping

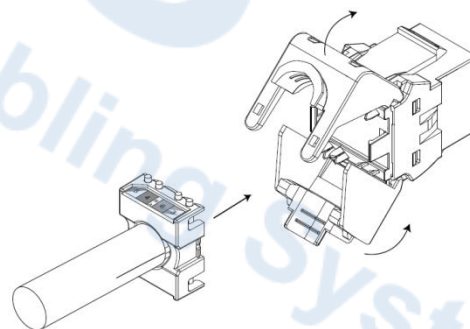

- 4) Serrare a mano o tramite l'uso di una pinza le alette di terminazione fino alla loro completa chiusura

Close the jack's termination wings by hands or using a crimping tool until their complete snap

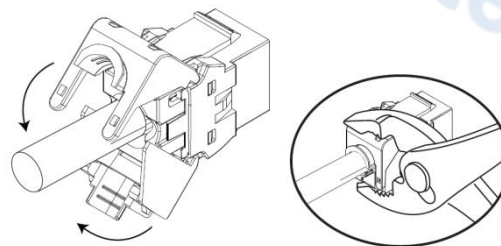

- 5) Arrotolare il filo di continuità attorno al punto di chiusura della presa e applicare la fascetta in dotazione

Wrap the drain wire around the cable fixing place and then use the supplied cable tie to fix it

